

2-WIRE IP VIDEO INTERCOM SYSTEM

DH470

7" IPS FULL VIEW ANGLE TFT MONITOR

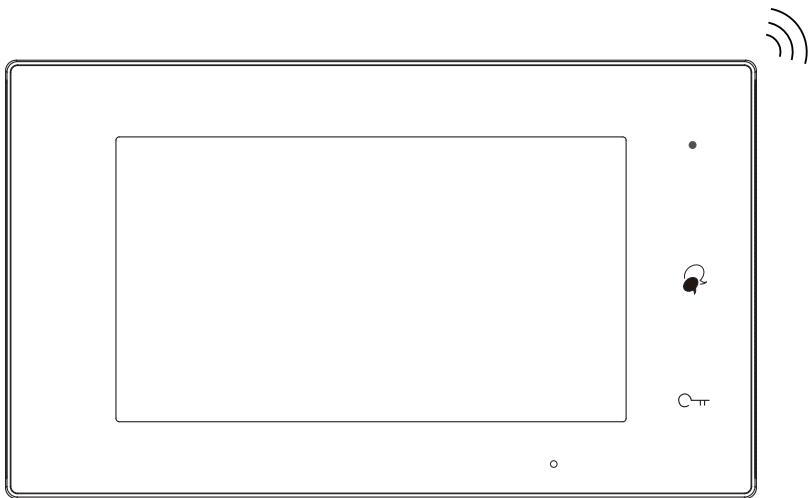

- Please read this manual carefully before using the product you purchase, and keep it well for future use.
- Please note that images and sketch maps in this manual may be different from the actual product.

1. Parts and Functions

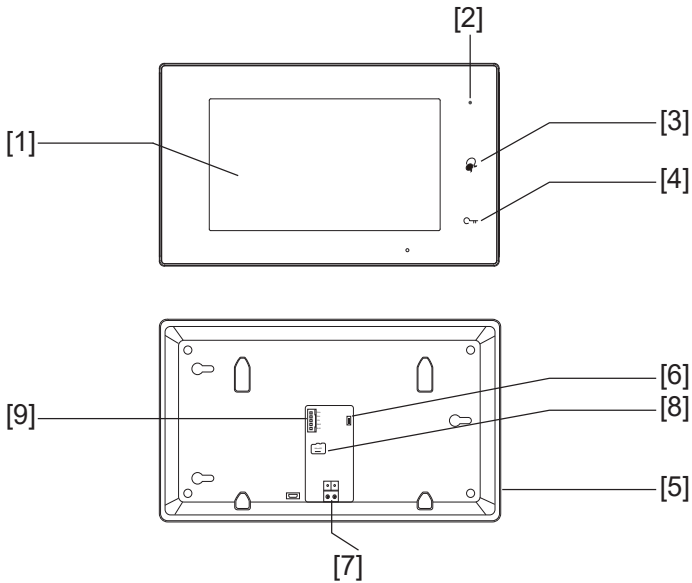

Key functions

| NO. | Item | Description |
|-----|--------------------------|---|
| [1] | Digital LCD touch screen | See the next page for details Display the visitors' image |
| [2] | Indicator LED | Show the status of monitor |
| [3] | Talk/Mon button | Press to communicate hands free with visitor Press to view the outdoor condition in standby mode |
| [4] | Unlock button | Unlock the door |
| [5] | Speaker | Send out sounds of ring tones, audios and alarms |
| [6] | Boot button | For firmware update |
| [7] | 2 wire connector | Bus terminal |
| [8] | SD card slot | Use to insert micro-SD card |
| [9] | Terminal connector | SW+,SW-: Extra door bell call button connection port. 12V,GND: Ringer connection port. |

2. Mounting

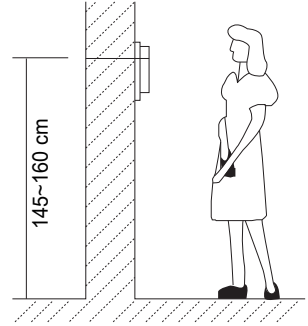
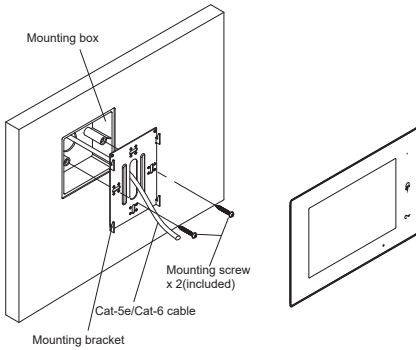

The installation height is suggested to 145~160cm.

1. Use screws to fasten the mounting bracket to the wall with mounting box.
2. Connect the 2 wire cables to the unit.
3. Mount the unit to the mounting bracket, make sure the unit is absolutely attached to the mounting bracket.

3. Main Menu

The Main menu is your starting point for using all the applications on your monitor.

Touch anywhere of the screen on monitor in standby mode, the Main menu will appear as follow:

The main menu of DH470

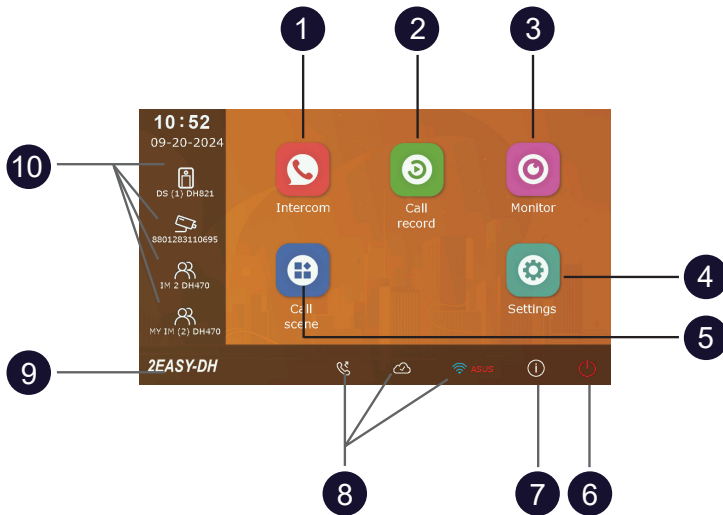

1 Intercom icon

Allows you to call other indoor station.

2 Call Record icon

Allows you to view the call record.

3 Monitor icon

Allows you to monitor the door stations, cameras.

4 Setting icon

Use to change the indoor station's settings.

5 Call Scene icon

Allows you to activate the functions of No disturb, Divert.

6 Close icon

Touch to turn off the screen.

7 About icon

Allows you to view the information about device.

8 Status bar

Displays icons that indicate the indoor station's status(see 4. Status bar icons(page4)).







9 Logo

Shows "2EASY-DH" by default. Means the brand of indoor station. Can be customized.



10 Shortcut windows

Touch to enter the corresponding items directly.

4. Status Bar Icons



| Icon | Description | |
|---|----------------------|---|
|  | Missed call | Display when there is missed call unread. Touch to review the missed call in shortcut. |
|  | No disturb | Indicates the device is in “No disturb” mode. |
|  | Divert call | Indicates the device is in “Divert call” mode. |
|  | Device online | Indicates device online, but not connect to internet. |
|  | Cloud server worked | Indicates the device is connected to the cloud server. |
|  | No cloud server | Indicates the device is not connected to the cloud server. |
|  | Cloud server anomaly | Indicates the device cloud server connection is abnormal. |

Other status icons

| Icon | Description | |
|---|-------------|--|
|  | Talking | Indicates the device is in “talking” status. |
|  | Unlock | Indicates open the corresponding door. |

5. Answering a Call

When you receive a call, the indoor station rings. Image will be displayed on the screen.

1. Touch  icon or press  **TALK/MON** button.

- Speak within about 50 cm of the microphone.
- Begin communicating hands free with the visitor for 90 seconds.

2. When finished, Touch  icon or press  **TALK/MON** button again.

Available functions while talking on a call

- Door release

Notes:

1.Receiving a call while talking with a door station

- Other door stations calling is forbidden
- Conclude current talking to answer the new call-in

2.Receiving a call while talking with other monitors

- The talking will stop immediately, call tone sounds in normal.
- The video image from the door station is displayed on the screen, talking,unlock,are available.

6. Monitoring

This section can be used to monitor your home by enabling one of the cameras inside the apartment, the common areas (e.g. garages, garden), and at the entrance.

1. From the main menu, tap **"Monitor"** icon.
2. Select the desired tap.
 - Allows you to select door station camera or IP camera(if the system installs multi door station or IP camera) .
3. Select the desired camera.
4. When finished, tap  button on panel.

* During monitoring, images can be viewed, but audio cannot be heard.

Available functions during monitoring:

- Door release

Note: Tap monitor quick actions to monitor corresponding camera directly(If the monitor quick actions is set on the shortcut windows).

7. Favorite Setting

This section can be used to set your favorite.

1. From the main menu, tap **"Monitor"** icon.
 - A list of available setting categories is displayed.
2. Select "Monitor" item.
3. Click the upper left corner of the item you need to select, and then the "  " icon will appear.
4. If you need to cancel, click the upper left corner again.



8. Making Calls

You can call other residences, common area phones or facility staff office, and even other rooms in your own residence.

whichever monitor answers the call, you can use many of the features described in feature available while talking on a call.

Namelist call by using the namelist

1. From the main menu, tap **"Intercom"** icon.
 - A list of available items is displayed.
2. Select "Namelist".
 - A list of name is displayed if the system allows.
3. Select the desired name.
 - Calling the target directly.

Inncall

If you have monitors installed in different rooms in your residence, you can call those rooms and use the system as an intercom.

1. From the main menu, tap **"Intercom"** icon.
 - A list of available items is displayed.
2. Select "Inner call".
 - A list of M/S is displayed.
3. Select the desired target.
 - Calling the target directly.

9. View Call Record

The monitor records information about calls from door station.

1. From the main menu, tap **"Call record"** icon.
2. Select the desired tap.
 - Incoming: Displays all calls from door station.
 - Tap the desired record will play the video.
 - *If the calls were missed, indicator LED will be flashing.
 - Delete all: Delete all the calls records.

Note :

1. If door station without SD card, video recording time is 3 seconds.
If door station with SD card, video recording time is 10 seconds by default
2. Support 512G SD card.

10. No Disturb Mode

During a certain period, if you don't want to be disturbed, you can go to set DND mode.

1. From the main menu, tap **"Call scene"** icon.
2. Select the desired tap.
 - No disturb 8H: Set to no disturb mode 8 hours.
 - No disturb always: Set to no disturb mode always.

Note:

* The no disturb indicator turns from green to red, to indicate that the no disturb function has been activated.

* This function will perform immediately if selected, and the status bar on main menu interface will show "🔕" icon.

11. Divert Calls

The calling from door station can be diverted to your smart phone. please note that this function should be supported by SIP network.

1. From the main menu, tap **"Call scene"** icon.
2. Select the desired tap.
 - Divert call if no answer: If nobody answers the call in 30s when receives call from door station, diverts the call to the smart phone. At this mode, the monitor will always open the screen and show image from door station during diverted, if the monitor answers the call at this time, diverted will conclude at once.
 - Divert call always: When receives call from door station, diverts the call to smart phone directly. At this mode, the monitor will shut off the screen after diverting successfully, but you can still use it in normal.





Note:

- * If divert the call to smart phone via Sip sever, need to choose one.
- * This function will perform immediately if selected, and the status bar on main menu interface will show "📞" icon.

12. Change the Monitor's Settings

1. From the main menu, tap **"Setting"** icon.
 - A list of available setting categories is displayed.
2. Select the desired tap.
3. Select the desired setting category.
4. Change the settings as desired.
5. Tap ← / 🏠 to save the new setting.

List of settings

| | |
|--|--|
|  Call Tune > | Ring volume - Ring timing - DS ring - Doorbell ring - Intercom ring - Innercall ring |
|  General > | Date and time - Language - Monitor timing - Name - Auto close after unlock - Auto unlock - Shortcut setting - SD card - Key tone |
|  Installer > | Call_Nbr - Parameter - Upgrade - Onsite tools - Restore factory settings |
|  Manager > | Wlan Setting - Sip config - Unlock code - Card manager |
|  Ext.Unit > | IPC camera - WLAN IPC camera |

Example: "DS ring"setting

1. From the main menu, tap **"Setting"** icon.
 - A list of available setting categories is displayed.
2. Select "Call Tune", and then tap "DS ring" item.
 - A list of available tune is displayed.
3. Select the tune as desired, and tap.
4. Tap ← / 🏠 to save the new setting.

Ring volume: adjust the ringtone volume.

Ring timing: adjust the ringtone time.

DS ring: call tone from door entrance panel.

DoorBell ring: call tone from doorbell.

Intercom ring: call tone from an intercom of another apartment.

InnerCall ring: call tone from an intercom in your apartment.

Example: "Date and time"setting

1. From the main menu, tap "**Setting**" icon.
 - A list of available setting categories is displayed.
2. Select "General", and then tap "Date and time" item.
 - Date and time seting interface is displayed.
3. Select and change the settings as desired.
4. Tap ← / 🏠 to save the new setting.

Date mode: 2 display mode: month/date/year and date/month/year

Time mode: 2 display mode: HOUR_12 and HOUR_24.

Date: touch it to set the date .

Time: touch it to set the time.

Internet time: touch it can synchronize the system time.

Example: "Language"setting

1. From the main menu, tap "**Setting**" icon.
 - A list of available setting categories is displayed.
2. Select "General", and then tap "Language" item.
 - Language interface is displayed.
3. Select and change the settings as desired.
4. Tap ← / 🏠 to save the new setting.

Example: "Shortcut setting"

1. From the main menu, tap "**Setting**" icon.
 - A list of available setting categories is displayed.
2. Select "General", Next page, and then tap "Shortcut setting" item.
 - Shortcut setting interface is displayed.
3. Select the type of function for which you want to add/remove a quick action.
4. Tap ← / 🏠 to save the new setting.

Note: Other settings are related to the system type. Please make settings according to the functions provided by your system.

13. Wi-Fi Connect

1. From the main menu, tap **"Setting"** icon.
- A list of available setting categories is displayed.
2. Select **"Manager"** item.
3. Select **"Wlan Setting"** item.
4. Turn the Wi-Fi switch on, and then the system will search the Wi-Fi.
5. Select the Wi-Fi you want, and input the password of Wi-Fi to connect.
6. Tap ← / 🏠 to save the new setting.

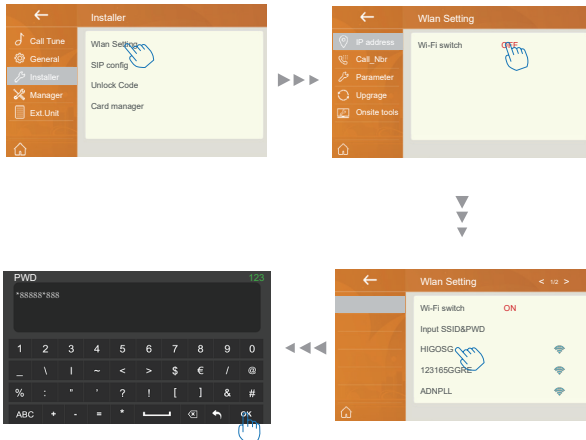

14. Address Setup

1. From the main menu, tap **"Setting"** icon.
 - A list of available setting categories is displayed.
2. Select "Installer", and then tap "Call_Nbr" item.
3. Input password if required (66666666 by default).

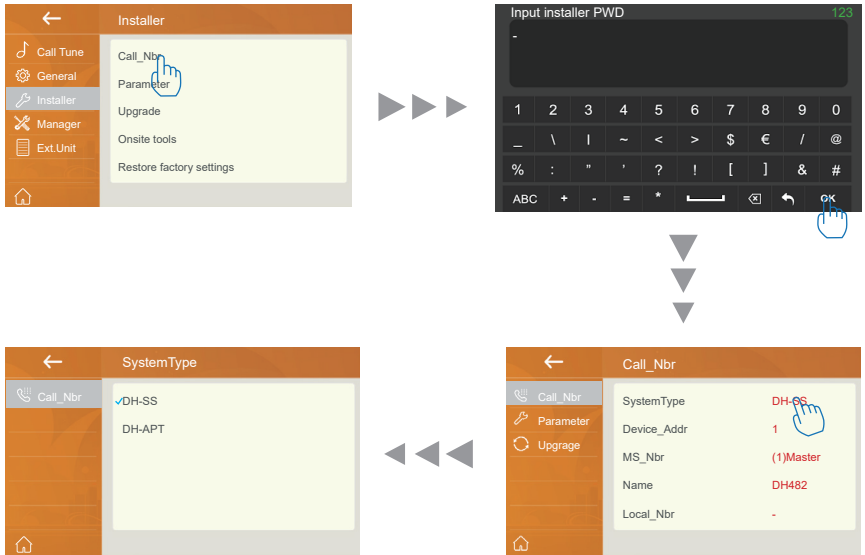

System Type:

"DH-SS": For small system that support max. 4 DH door stations (with 1-4 call buttons) and 8 DH monitors.

"DH-APT": Support max. 64 apartments.

RM_Nbr: To set the room number of the monitor.

MS_NBR:

Master and slave number, 01 is master monitor, 02~32 is slave monitor.

Name:

The "Name" input here will sync to door station's calling list automatically.

Global_Nbr: Reserved.

Local_Nbr: Reserved.

15. Upgrade

1. From the main menu, tap **"Setting"** icon.
 - A list of available setting categories is displayed.
2. Select "Installer", and then tap "Upgrade" item.
3. Input installer password (66666666 by default)

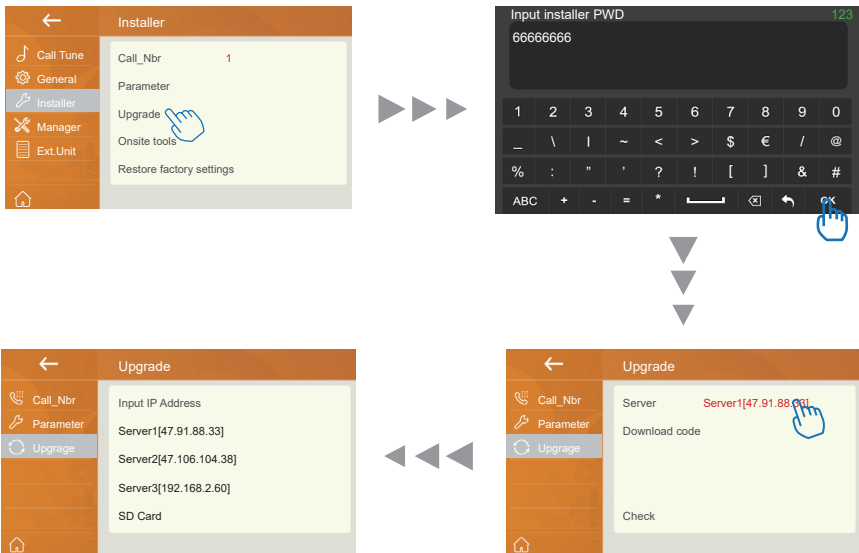

Tap “Server” to select firmware source, update firmware could come from as below, tap on the source:

1. **Cloud Server**
Cloud server requires internet.
Server1[47.91.88.33]
Server2[47.106.104.38]
2. **Local LAN Server3 (Reserved)**
Server3[192.168.2.60] #IX-Builder default IP
[Input IP address]
3. **SD card**
Copy upgrade firmware before upgrade.
SD card

After tap “Download code” and input code, the code could get from v-tec support team when device needed to update. After all, tap “Check” to load upgrade information from source.

With tips on the screen as below:

- Please insert SD card.** #Some upgrade is oversized, require SD card to store firmware.
- Mismatched.** #Update firmware was founded, but is not suitable for this device.
- Connect Error.** #Check networks.
- No file.** #Source has been inspected but there is no firmware need to upgrade.

Otherwise the device will go into upgrade automatically, please do not power off during upgrade.

16. SIP Config

It's available to divert the call to mobile while out of home via SIP server.

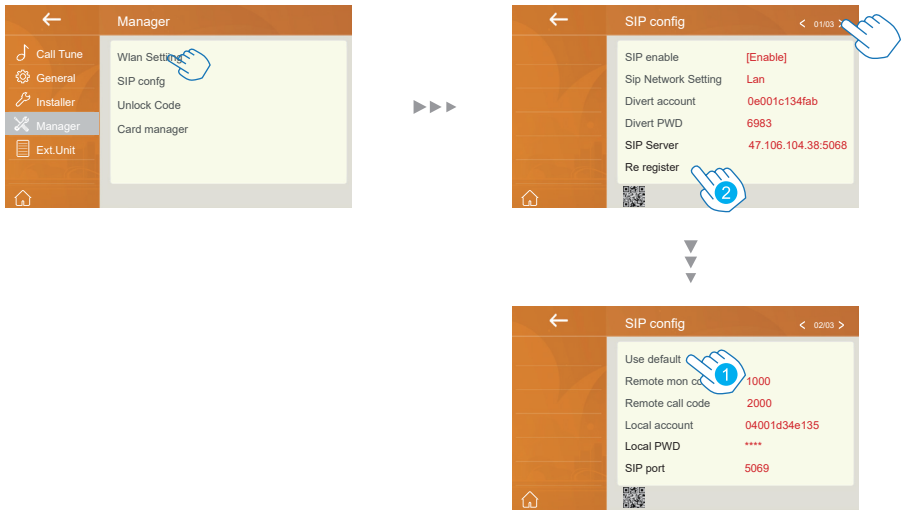

1 Touch it to restore all settings on “SIP config” and create 2 SIP accounts, one for DH monitor and one for VDP Connect APP. Server will apply to restore two accounts’ password to default, and register it. Only when:

- If your DH monitor is not brand new, we suggest you touch “Use default” before testing.

- VDP Connect APP is not able to register on server.

2 Touch it, DH monitor will apply to clean all SIP “contact” on server, and also will try to register itself to server, with this function it will helps when:

- VDP Connect APP is not able to get push notification.

- DH monitor has connect with Wi-Fi, but “Server” icon with “!” or “x” beside.

17. How to add IP camera to IP monitor

Preparation

Select the appropriate IP camera to access the system on demand. And set parameters for the IP camera.

Video Codec

An Onvif IP camera could be added to DH monitor, as long as this IPC could support following video codec: H264B/H264/H264H

- * 1. MJPEG decoding is not supported.
- 2. Some IPC can support both audio and video streams, please select video stream.

Preset the IP Camera before establishing a connection to the DH monitor

The setting interface of each IP camera brand are different. Please set the following items according to the actual situation.

Network

Choose to set DHCP or STATIC depending on the system.

Video

Each stream type need to do setting separately.

| | Main Stream (Full screen) | Tri-Stream (App view) |
|-------------------------|--|---------------------------|
| Encoding | Only H264 is supported | |
| Resolution | 1280*720 | 320*240 |
| FPS(Frames per second) | acceptable setting range: 15 ~ 18, 15 is the Best recommendation | |
| Bit Rate | 700~1024kbs | 512kbs~640kbs |
| BitRate Control | CBR is the Best recommendation | |

2. Add by search or manual.

3. Login

4. Save

Delete IP camera

main menu → Settings → Ext.Unit → IPC camera / Wlan IPC camera → chose → Delete

18. Download Setup VDP Connect APP

1. Scan and download VDP Connect APP, or search “VDP Connect” on APP store.

IOS



Android



2. Permit “VDP Connect” with permissions, tap screen of IP monitor → Settings → Manager → SIP config → .

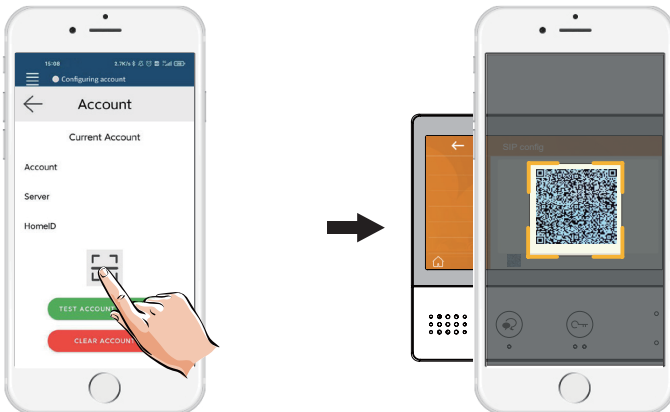

3. After login SIP account on VDP Connect APP, check on status bar, or tap on the “Connected” area to manually register, until VDP Connect display:

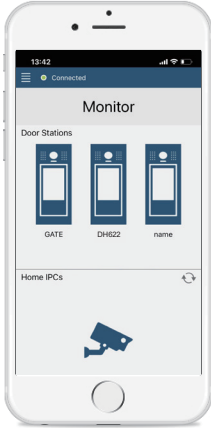

19. Surveillance door station via VDP Connect APP

On VDP CONNECT APP, press on the icon and wait for a few second.
If the system have multiple door stations,you can switch to view the door station you want. And push PTT icon to talk, or push unlock icon to open the door.



20. Specification

- Power Source: DC 20~28V
- Power consumption: Standby 1.5W; Working 4W
- Monitor screen: 7" IPS full view angle TFT
- Display Resolutions: 1024*600 resolution
- Wire Type: 2-wire
- Wiring Distance: 100m (Approx. 330')
- Operating temperature: -10 to +50 (oC)
- Dimension: 161(H)×174(W)×22(D)mm(IX470H)

21. Precautions

- 1) All components should be protected from violence vibration. And not allow to be impacted, knocked and dropped.
- 2) Please do the cleanness with soft cotton cloth, please do not use the organic impregnant or chemical clean agent. If necessary, please use a little pure water or dilute soap water to clean the dust.
- 3) Image distortion may occur if the video monitor is mounted too close to magnetic field e. g. Microwaves, TV, computer etc.
- 4) Please keep away the monitor from wet, high temperature, dust, caustic and oxidation gas in order to avoid any unpredictable damage.
- 5) Must use the right adaptor which is supplied by the manufacturer or approved by the manufacturer.
- 6) Pay attention to the high voltage inside the products, please refer service only to a trained and qualified professional.

