

2 WIRE HOME Wi-Fi SYSTEM

DX470-TD7

7" IPS FULL VIEW ANGLE TFT MONITOR

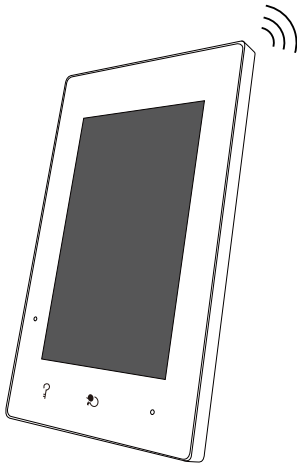

DX470V-TD7

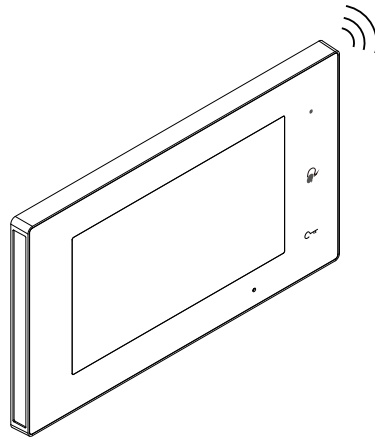

DX470H-TD7

- Please read this manual carefully before using the product you purchase, and keep it well for future use.
- Please note that images and sketch maps in this manual may be different from the actual product.

Contents

1.Parts and Functions.....	1
2.Mounting.....	2
3.Main Menu.....	2
4. Status Bar Icons.....	5
5.Answering a Call.....	6
6.Monitoring.....	7
7.Main Menu Switching.....	7
8.Favorite Setting.....	8
9.PIP View.....	8
10.Quad View.....	9
11.Making Calls.....	10
12.View Call Record.....	11
13.No Disturb Mode.....	12
14.Divert Calls.....	13
15.Change the Monitor's Settings.....	13
16.Address Setup.....	17
17.Upgrade.....	18
18.Reboot.....	19
19.SIP Config.....	20
20.IPC Setting.....	21
21.Restore Factory Settings.....	21
22.Download Setup VDP Connect APP.....	22
23.Surveillance door station VDP Connect APP.....	23
24.Specification.....	24
25.Precautions.....	24

1. Parts and Functions

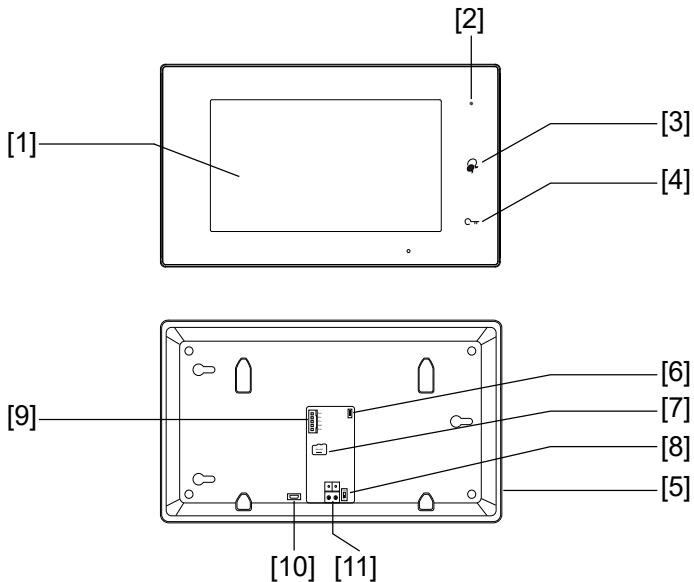

Key functions

NO.	Item	Description
[1]	Digital LCD touch screen	See the next page for details. Display the visitors' image.
[2]	Power/No Disturb indicator	Show the power status of the system. Show the no disturb status.
[3]	Talk/Mon button	Press to communicate hands free with visitor. Press to view the outdoor condition in standby mode.
[4]	Unlock button	Press to release the door.
[5]	Speaker	Send out sounds of ring tones, audios and alarms.
[6]	Upgrade button	Use to upgrade the software.
[7]	SD card slot	Use to insert micro-SD card
[8]	DIP	Use to set video match.
[9]	Terminal connector	SW+,SW-: Extra door bell call button connection port. GND,BUS: Extra buzzer connection port.
[10]	Micro USB socket	For data transfer.
[11]	2 wire connector	For 2 wire system.

2. Mounting

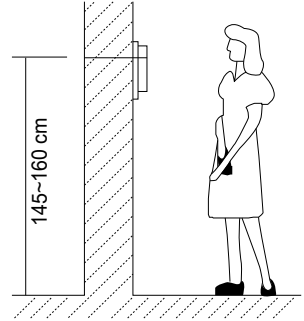
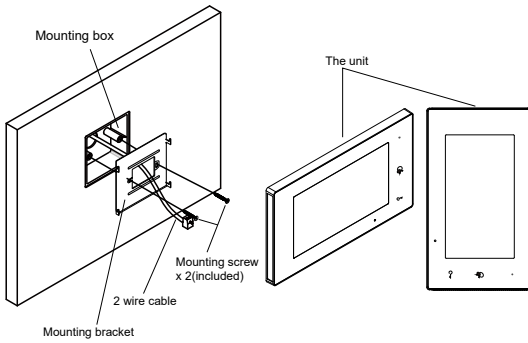

The installation height is suggested to 145~160cm.

1. Use screws to fasten the mounting bracket to the wall with mounting box.
2. Connect the 2 wire cable to the unit.
3. Mount the unit to the mounting bracket, make sure the unit is absolutely attached to the mounting bracket.

3. Main Menu

The Main menu is your starting point for using all the applications on your monitor.

Touch **Unlock** button, or touch anywhere of the screen on monitor in standby mode, the Main menu will appear as follow:

The main menu of DX470V



1 Status bar

Displays icons that indicate the indoor station's status(see 4. Status bar icons(page4)).

2 About icon

Allows you to view the information about device.

3 Shortcut windows

Touch to enter the corresponding items directly.

4 Intercom icon

Allows you to call other indoor station.

5 Call Record icon

Allows you to view the call record.

6 Monitor icon

Allows you to monitor the door stations, cameras.

7 Call Scene icon

Allows you to activate the functions of No disturb, Divert.

8 Setting icon

Use to change the indoor station's settings.

9 Logo

Shows "2EASY" by default. Means the brand of indoor station. Can be customized.

10 Close icon

Touch to turn off the screen.

The main menu of DX470H

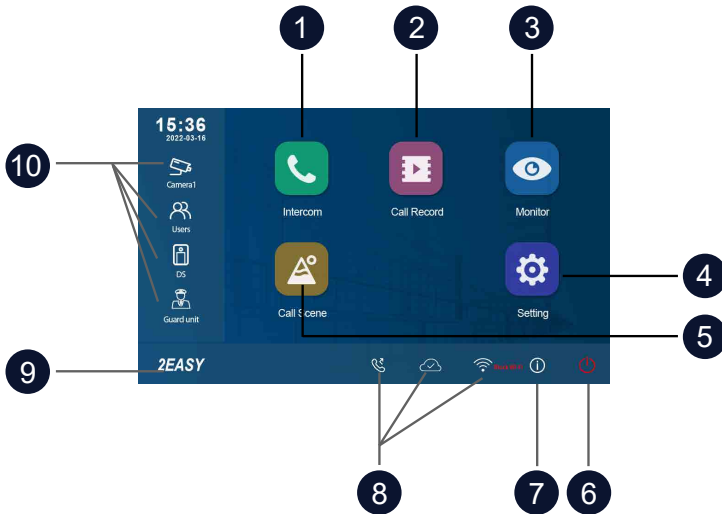

1 Intercom icon

Allows you to call other indoor station.

2 Call Record icon

Allows you to view the call record.

3 Monitor icon

Allows you to monitor the door stations, cameras.

4 Setting icon

Use to change the indoor station's settings.

5 Call Scene icon

Allows you to activate the functions of No disturb, Divert.

6 Close icon

Touch to turn off the screen.

7 About icon

Allows you to view the information about device.

8 Status bar

Displays icons that indicate the indoor station's status(see 4. Status bar icons(page4)).









9 Logo

Shows "2EASY" by default. Means the brand of indoor station. Can be customized.



10 Shortcut windows

Touch to enter the corresponding items directly.

4. Status Bar Icons



Icon	Description	
	Missed call	Display when there is missed call unread. Touch to review the missed call in shortcut.
	No disturb	Indicates the device is in “No disturb” mode.
	Divert call	Indicates the device is in “Divert call” mode.
	Device online	Indicates device online, but not connect to internet.
	Cloud server worked	Indicates the device is connected to the cloud server.
	No cloud server	Indicates the device is not connected to the cloud server.
	Cloud server anomaly	Indicates the device cloud server connection is abnormal.
	mute	Indicates the device is in “Mute” mode.

Other status icons



Icon	Description	
	Recording	Indicates the device is recording
	Talking	Indicates the device is in “talking” status.
	Unlock	Indicates open the corresponding door.

5. Answering a Call

When you receive a call, the indoor station rings. Image will be displayed on the screen.

1. Touch  icon or press  **TALK/MON** button.

- Speak within about 50 cm of the microphone.
- Begin communicating hands free with the visitor for 90 seconds.

2. When finished, Touch  icon or press  **TALK/MON** button again.

Available functions while talking on a call

- Door release
- Manual recording

Notes:

1.Receiving a call while talking with a door station

- Other door stations calling is forbidden
- Conclude current talking to answer the new call-in

2.Receiving a call while talking with other monitors

- The talking will stop immediately, call tone sounds in normal.
- The video image from the door station is displayed on the screen, talking,unlock,capture images/videos are available.

6. Monitoring

This section can be used to monitor your home by enabling one of the cameras inside the apartment, the common areas (e.g. garages, garden), and at the entrance.

1. From the main menu, tap **"Monitor"** icon.
2. Select the desired tap.
 - Allows you to select door station camera or IP camera(if the system installs multi door station or IP camera) .
3. Select the desired camera.
4. When finished, tap  button on panel.

* During monitoring, images can be viewed, but audio cannot be heard.

Available functions during monitoring:

- Door release
- Manual recording

Note: Tap monitor quick actions to monitor corresponding camera directly(If the monitor quick actions is set on the shortcut windows).

7. Main Menu Switching

This section can be used to switch the menu for DX470H & DX470V.

The Steps are as follows:

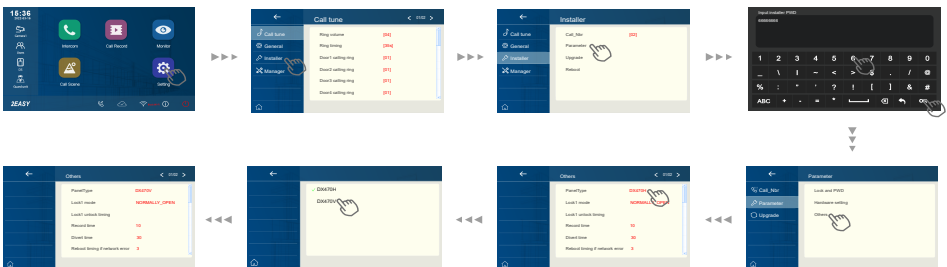

After restart, you can switch to the new menu.

***All of the following have been explained by taking the DX470H menu as an example.**

8. Favorite Setting

This section can be used to set your favorite.

1. From the main menu, tap **"Monitor"** icon.
- A list of available setting categories is displayed.
2. Select "Monitor" item.
3. Click the upper left corner of the item you need to select, and then the "★" icon will appear.
4. If you need to cancel, click the upper left corner again.



9. PIP View

Precondition: this function requires the system to access the cameras or set the camera proxy settings.

The picture-in-picture display allows the user to see two images from different sources at the same time during the call, which is convenient for the user to see the visitor intuitively and concretely.

Press call button
on door station

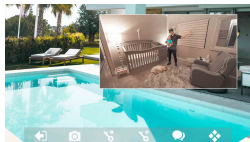

Feature of PIP view:

- in call mode
- Picture in picture to avoid dead corner
- Able to watch both views from door station and IP camera
- Swap the two images by a simple touch

10. Quad View

Precondition: this function requires the system to access the cameras or set the camera proxy settings.

The Quad display allows the user to view four images quickly and simultaneously from different video resource, and to quickly switch & zoom in on a screen by one click.



Feature of quad view:

- In monitor mode
- Able to display four images on a screen
- switch seamlessly between One-view and Quad-view
- free to zoom in any views

11. Making Calls

You can call other residences, common area phones or facility staff office, and even other rooms in your own residence.

whichever monitor answers the call, you can use many of the features described in feature available while talking on a call.

Namelist call by using the namelist

1. From the main menu, tap **"Intercom"** icon.
 - A list of available items is displayed.
2. Select "Namelist".
 - A list of name is displayed if the system allows.
3. Select the desired name.
 - Calling the target directly.

Inncall

If you have monitors installed in different rooms in your residence, you can call those rooms and use the system as an intercom.

1. From the main menu, tap **"Intercom"** icon.
 - A list of available items is displayed.
2. Tap "Inncall" item to call.

Calling guard station

1. From the main menu, tap **"Intercom"** icon.
 - A list of available items is displayed.
2. Select "Guard station".
 - Calling the target directly.

12. View Call Record

The monitor records information about calls you have answered, missed, and made, and saves it in the call record. See the following steps to view the call record.

1. From the main menu, tap **"Call record"** icon.
2. Select the desired tap.
 - Missed: Displays calls you received but did not answer.
 - Incoming: Displays calls you answered.
 - Outgoing: Displays calls you made.
 - Playback: Displays pictures/videos you received / made.
3. Browse the call record as needed.
4. When finished, tap ← , return to previous menu.(or tap  return to home page)

Play videos

you can record camera video manually while talking to a visitor or monitoring camera video. See the following steps to play the video.

1. From the main menu, tap **"Call record"** icon.
2. Select the desired tap.
3. Tap the desired call record.
 - Displays the images/videos
4. When finished, tap ← .

Controlling video playback

The following controls are available by tapping the screen while playing an image/video.



Plays the video.

 Plays the next video.

 Plays the previous video.

 Delete video.

 Delete confirm.

Note:

1. If without SD card, video recording time is 3 seconds. Up to 10 videos can be saved, Subsequent records will overwrite the oldest items.
If with SD card, video recording time is 10 seconds by default (Max 600 seconds could be set or customized).
2. Support 512G SD card.

13. No Disturb Mode

During a certain period, if you don't want to be disturbed, you can go to set DND mode.

1. From the main menu, tap "**Call scene**" icon.
2. Select the desired tap.
 - No disturb 8H: Set to no disturb mode 8 hours.
 - No disturb always: Set to no disturb mode always.

Note:

* The no disturb indicator turns from green to red, to indicate that the no disturb function has been activated.

* This function will perform immediately if selected, and the status bar on main menu interface will show "" icon.

14. Divert Calls

The calling from door station can be diverted to your smart phone. please note that this function should be supported by SIP network.

1. From the main menu, tap **"Call scene"** icon.
2. Select the desired tap.
 - Divert call if no answer: If nobody answers the call in 30s when receives call from door station, diverts the call to the smart phone. At this mode, the monitor will always open the screen and show image from door station during diverted, if the monitor answers the call at this time, diverted will conclude at once.
 - Divert call always: When receives call from door station, diverts the call to smart phone directly. At this mode, the monitor will shut off the screen after diverting successfully, but you can still use it in normal.





Note:

- * If divert the call to smart phone via Sip sever, need to choose one.
- * This function will perform immediately if selected, and the status bar on main menu interface will show "📞" icon.

15. Change the Monitor's Settings

1. From the main menu, tap **"Setting"** icon.
 - A list of available setting categories is displayed.
2. Select the desired tap.
3. Select the desired setting category.
4. Change the settings as desired.
5. Tap ← / 🏠 to save the new setting.

List of settings

 Call Tune >	Ring volume - Ring timing - Door1/2/3/4 calling ring - Doorbell ring - Intercom ring - Innercall ring - GuardCall ring
 General >	Date and time - Language - Monitor timing - Shortcut setting - SD card - Auto close after unlock - Auto unlock - Name - Key tone - Screen on in divert
 Installer >	Call_Nbr - Parameter - Upgrade - Reboot
 Manager >	Sip config - Wlan Setting - IPC camera - Back and restore

Ring tone setting

The ring call tone can be set individually to distinguish different calling sources. Totally 22 tones can be selected.

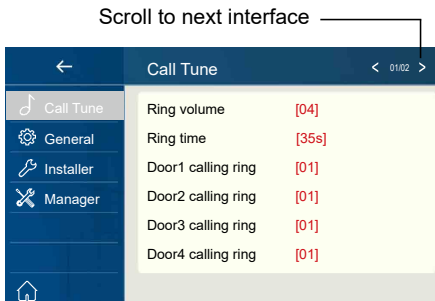

Ring volume: adjust the ringtone volume.

Ring timing: adjust the ringtone time.

Door1/2/3/4 calling ring: call tone from door entrance panel.

DoorBell ring: call tone from doorbell.

Intercom ring: call tone from an intercom of another apartment.

InnerCall ring: call tone from an intercom in your apartment.

GuardCall ring: call tone from Guard unit.

General setting

This section contains the general settings and device information.

1. Select [**General**] item to enter general setting interface.

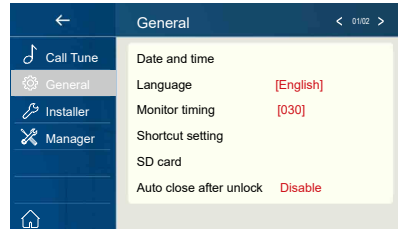

Date and time setting

The current date and time can be modified at any time.

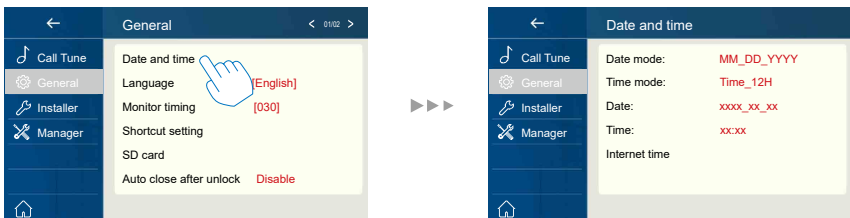

Date mode: 2 display mode: month/date/year and date/month/year

Time mode: 2 display mode: HOUR_12 and HOUR_24.

Date: touch it to set the date .

Time: touch it to set the time.

Internet time: can synchronize the system time.

Changing the display language

The default language can be customized. But you can change it to your desire language at any time.

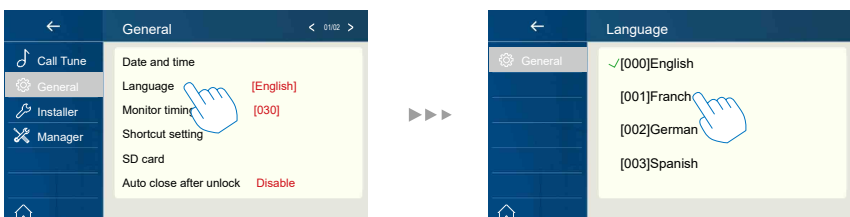

*If the target language is not found in the window, touch > icon to scroll next interface.

Setting monitor time

The monitor time can be changed at any time. It's available to set 30s, 60s, 90s, 120s, 150s, 180s, 210s, 240s, 270s, 300s.

* 30s is the default monitor time.

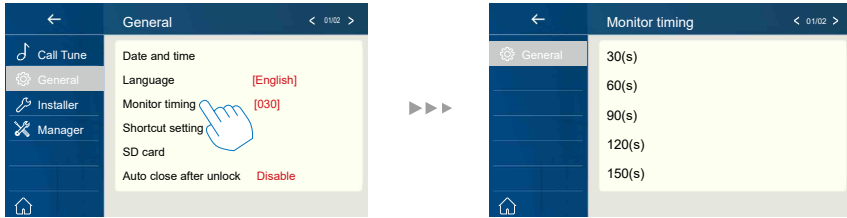

Shortcut setting

In this section it is possible to select the 4 quick actions that will appear on the home interface.

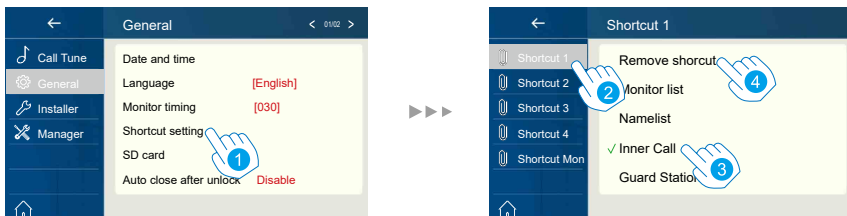

1. Touch it to enter the shortcut set interface.
2. Select the shortcut set item you want.
3. Select the type of function for which you want to add a quick action.
4. Remove the quick action from the home interface.

SD card

If the device insert an SD card, the SD card info can be reviewed on the device.

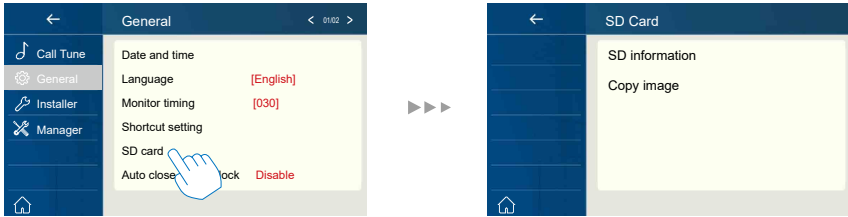

SD information:SD card capacity.

Copy image: touch it to copy the recorded images to SD Card.

16. Address Setup

1. From the main menu, tap "**Setting**" icon.
 - A list of available setting categories is displayed.
2. Select "Installer", and then tap "Call_Nbr" item.
3. Input installer password (66666666 by default, or password free when door station into installer mode and enable it)
4. Input the room number.

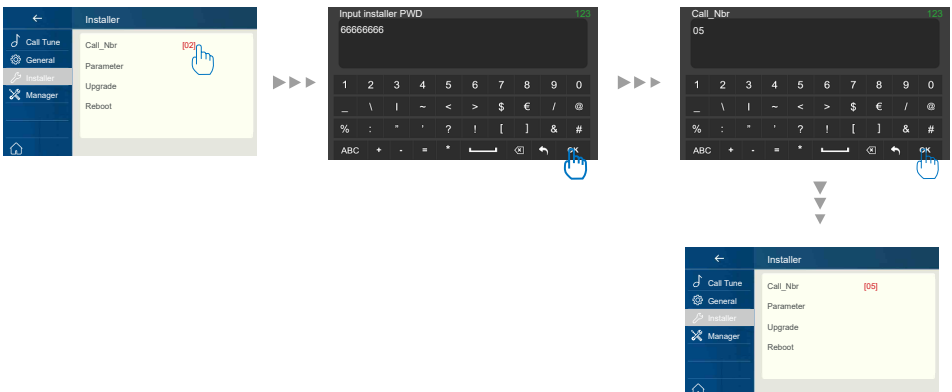

17. Upgrade

1. From the main menu, tap "**Setting**" icon.
- A list of available setting categories is displayed.
2. Select "Installer", and then tap "Upgrade" item.
3. Input installer password (66666666 by default, or password free when door station into installer mode and enable it)

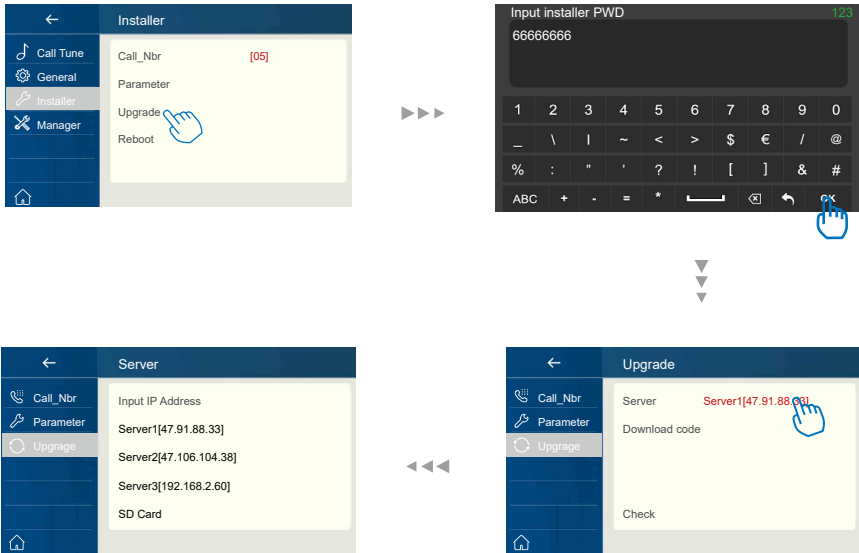

Tap "Server" to select firmware source, update firmware could come from as below, tap on the source:

1. **Cloud Server**
Cloud server requires internet.
Server1[47.91.88.33]
Server2[47.106.104.38]
2. **SD card**
Copy upgrade firmware before upgrade.
SD card

After tap “Download code” and input code, the code could get from v-tec support team when device needed to update. After all, tap “Check” to load upgrade information from source.

With tips on the screen as below:

- Please insert SD card.** #Some upgrade is oversize, require SD card to storage firmware.
- Mismatched.** #Update firmware was founded, but is not suitable for this device.
- Connect Error.** #Check networks.
- No file.** #Source has been inspected but there is no firmware need to upgrade.

Otherwise the device will go into upgrade automatically, please do not power off during upgrade.

18. Reboot

It's available to Auto reboot ,or Reboot the device.

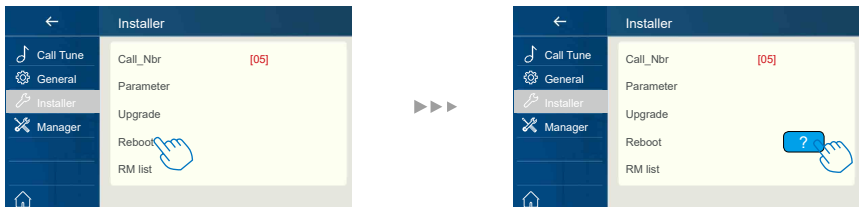

19. SIP Config

It's available to divert the call to mobile while out of home via SIP server.



1. Touch it to restore all settings on “SIP config” and create 2 SIP accounts, one for DX monitor and one for VDP Connect APP. Server will apply to restore two accounts’ password to default, and register it. Only when:

- If your DX monitor is not brand new, we suggest you touch “Use default” before testing.

- VDP Connect APP is not able to register on server.

2. Touch it, DX monitor will apply to clean all SIP “contact” on server, and also will try to register itself to server, with this function it will helps when:

- VDP Connect APP is not able to get push notification.

- DX monitor has connect with Wi-Fi, but “Server” icon with “!” or “x” beside.

20. IPC Setting

It's available to set the related function of IP camera.

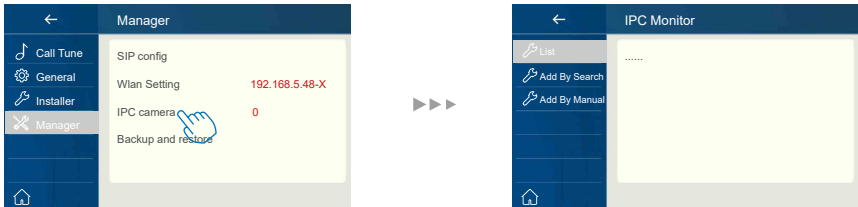

Add IPC by searching: Add the IP camera by searching online.

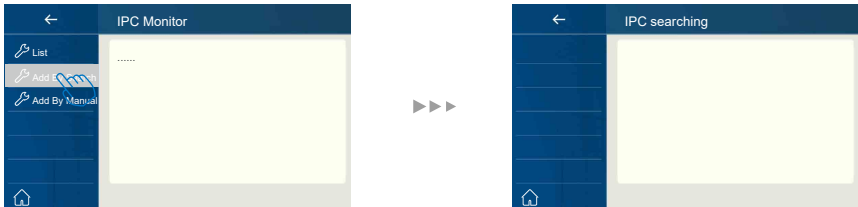

Add IPC by Manual: Add the IP camera by manual.

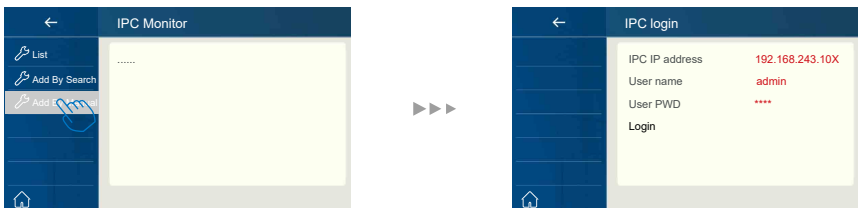

21. Restore Factory Settings

This device allows the user to recover the settings to factory setting.

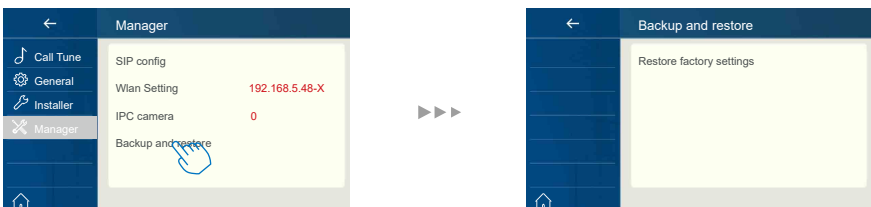

22. Download Setup VDP Connect APP

1. Scan and download VDP Connect APP, or search “VDP Connect” on APP store.

IOS



Android



2. Permit “VDP Connect” with permissions, tap screen of IP monitor → Settings → Manager → SIP config → 

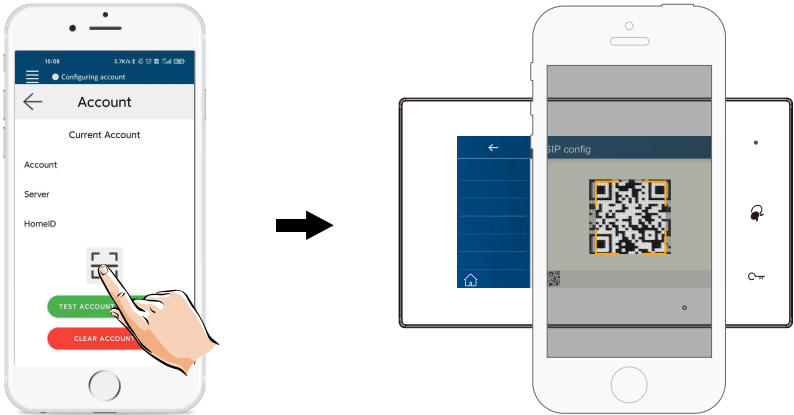

3. After login SIP account on VDP Connect APP, check on status bar, or tap on the “Connected” area to manually register, until VDP Connect display:

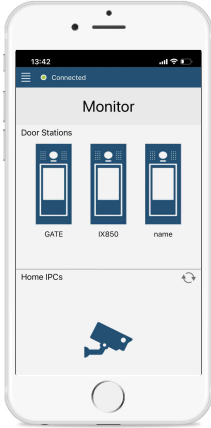

23. Surveillance door station via VDP Connect APP

On VDP CONNECT APP, press on the icon and wait for a few seconds. If the system have multiple door stations,you can switch to view the door station you want. And push PTT icon to talk, or push unlock icon to open the door.



24. Specification

- Power supply: DC 20~28V
- Power consumption: Standby 1.7W; Working 8.2W
- Monitor screen: 7" IPS full view angle TFT
- Display Resolutions: 1024*600 resolution
- Wire Type: 2 wires, non-polarity
- Wiring Distance: 100m (Approx. 330')
- Operating temperature: -10 to +50 (oC)
- Dimension: 161(H)×174(W)×22(D)mm(DX470H)
- 174(H)×161(W)×22(D)mm(DX470V)

25. Precautions

- 1) All components should be protected from violence vibration. And not allow to be impacted, knocked and dropped.
- 2) Please do the cleanness with soft cotton cloth, please do not use the organic impregnant or chemical clean agent. If necessary, please use a little pure water or dilute soap water to clean the dust.
- 3) Image distortion may occur if the video monitor is mounted too close to magnetic field e. g. Microwaves, TV, computer etc.
- 4) Please keep the monitor away from wet, high temperature, dust, caustic and oxidation gas in order to avoid any unpredictable damage.
- 5) Must use the right adaptor which is supplied by the manufacturer or approved by the manufacturer.
- 6) Pay attention to the high voltage inside the products, please refer service only to a trained and qualified professional.

