

2 WIRE INTERCOM SYSTEM

DK1731-81 KIT

Quick Guide

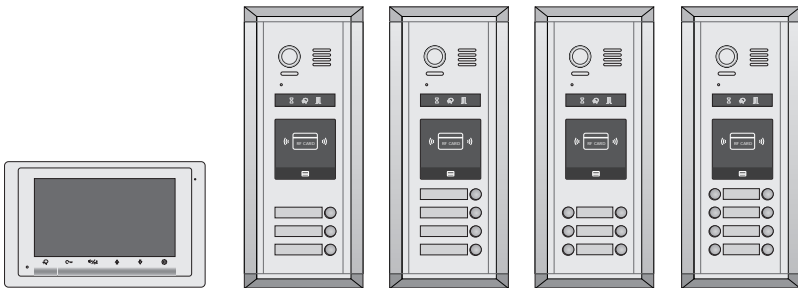

Please read this manual carefully before using the product you purchase, and keep it well for future use. We reserve the right to modify the specification in this manual at any time without notice.

1. Product Lists Of Kits

Kit DK1731S/ID consists of

- 1* Outdoor Station- DMR11S/ID/S3
- 1* Surface Box- RH-MR11
- 3* Indoor Units- DT17S
- 1* Four Outputs Controller- DT-DBC4A1
- 1* Power Supply with UL approved- DR-30-24
- 1* Power Separator- DT-DPS
- 1* DIN Rail
- 1* Relay- DS-ERL
- 1* AWG18 Power Cable
- 2* Management Cards- Add Card & Delete Card
- 6* Proximity Cards

Kit DK1741S/ID consists of

- 1* Outdoor Station- DMR11S/ID/S4
- 1* Surface Box- RH-MR11
- 4* Indoor Units- DT17S
- 1* Four Outputs Controller- DT-DBC4A1
- 1* Power Supply with UL approved- DR-30-24
- 1* Power Separator- DT-DPS
- 1* DIN Rail
- 1* Relay- DS-ERL
- 1* AWG18 Power Cable
- 2* Management Cards- Add Card & Delete Card
- 8* Proximity Cards

Kit DK1761S/ID consists of

- 1* Outdoor Station- DMR11S/ID/D6
- 1* Surface Box- RH-MR11
- 6* Indoor Units- DT17S
- 2* Four Outputs Controller- DT-DBC4A1
- 1* Power Supply with UL approved- DR-30-24
- 1* Power Separator- DT-DPS
- 1* DIN Rail
- 1* Relay- DS-ERL
- 1* AWG18 Power Cable
- 2* Management Cards- Add Card & Delete Card
- 12* Proximity Cards

Kit DK1781S/ID consists of

- 1* Outdoor Station- DMR11S/ID/D6
- 1* Surface Box- RH-MR11
- 8* Indoor Units- DT17S
- 2* Four Outputs Controller- DT-DBC4A1
- 1* Power Supply with UL approved- DR-30-24
- 1* Power Separator- DT-DPS
- 1* DIN Rail
- 1* Relay- DS-ERL
- 1* AWG18 Power Cable
- 2* Management Cards- Add Card & Delete Card
- 16* Proximity Cards

2. System Connection

In-out wiring without any distributor

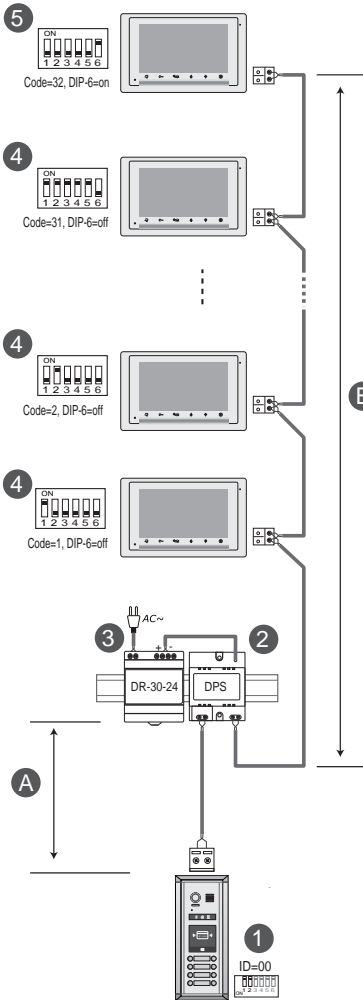

[1]: Door Station, when there is only one Door Station, the DIP bit-1 and bit-2 should be set to 00.

[2]: Power Supply(DR-30-24), MUST be installed side by side with the DPS unit.

[3]: Power Separator, MUST be installed side by side with the DR-30-24 unit.

[4]: Monitor, each one with a unique User Code (Max.32 Monitors), the bit-6 of the DIP should be set to 0 (off) if the Monitor is not at the end of the bus line.

[5]: Monitor, the bit-6 of the DIP should be set to 1 (on) if the Monitor is connected at the end of the bus line.

When Monitor quantity < 20

Cable Usage	A	B
Twisted cable 2x0.00116 sq.in	196ft	196ft
Twisted cable 2x0.00155 sq.in	262ft	262ft

When Monitor quantity > 20

Cable Usage	A	B
Twisted cable 2x0.00155 sq.in	229ft	98ft
Twisted cable 2x0.00233 sq.in	229ft	164ft

Note: The thicker the copper wire is, the longer distances will be. Best wire to use is 18 Gauge twisted, while Cat 5 or 6 are not recommended.

Star wiring with 4 output distributor DBC4A1

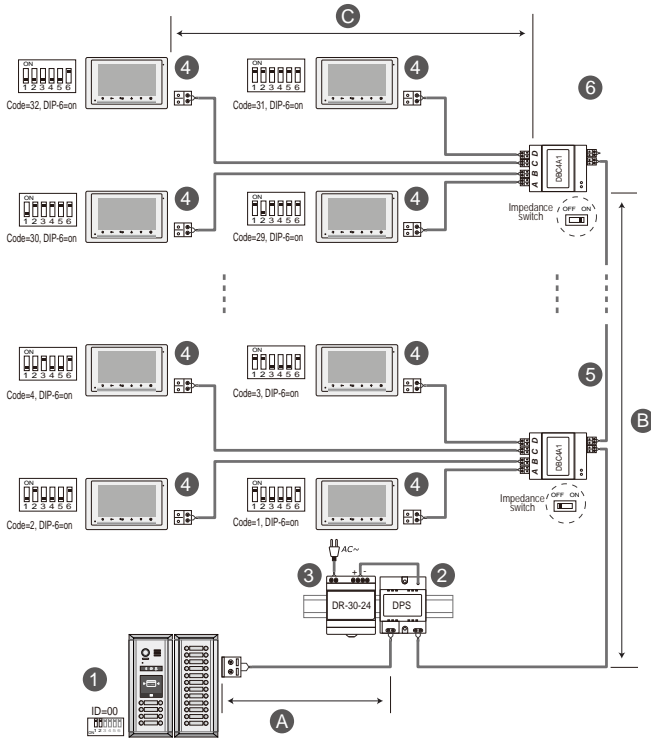

[1]: Door Station, when there is only one Door Station, the DIP bit-1 and bit-2 should be set to 00.

[2]: Power Supply(DR-30-24), MUST be installed side by side with DPS unit.

[3]: Power Separator, MUST be installed side by side with the DR-30-24 unit.

[4]: Monitor, each one with a unique User Code, note that all the bit-6 of the DIP should be set to 1 (on) in this case.(Max.32 Monitors)

[5]: 4 output distributor DBC4A1,Impedance switch of all DBC4A1 should be set to OFF, except the last DBC4A should be set to ON. (When there is only 1 DBC4A1, should set to ON).

When Monitor quantity < 20

Cable Usage	A	B	C
Twisted cable 2x0.00116 sq.in	196ft	196ft	98ft
Twisted cable 2x0.00155 sq.in	262ft	262ft	131ft

When Monitor quantity > 20

Cable Usage	A	B	C
Twisted cable 2x0.00155 sq.in	229ft	98ft	65ft
Twisted cable 2x0.00233 sq.in	229ft	164ft	98ft

Note: The thicker the copper wire is, the longer distances will be. Best wire to use is 18 Gauge twisted, while Cat 5 or 6 are not recommended.

3. Parts and Functions

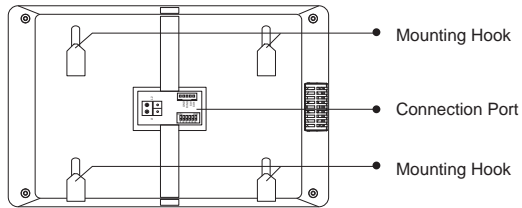
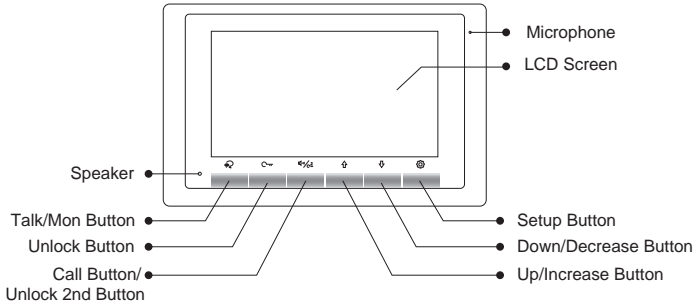

Key functions

Item	Description
Microphone	Receive voice from the user.
LCD screen	Display the visitors' image.
Setup button	Press to select the setting item you want.
Down/Decrease button	Press to decrease the value.
Up/Increase button	Press to increase the value.
Speaker	Send out voice from the visitor.
Talk/Mon button	Press to communicate hands free with visitor; Press to view the outdoor condition in standby mode.
Unlock button	Press to release the door
Call button/Unlock 2nd button	In standby mode, pick up handset, then press Call button to activate the inner call; During calling/talking state, press Unlock 2nd button to release the second door.
Mounting hook	Use to hang up the monitor.
Connection port	Bus terminal.

Terminal description

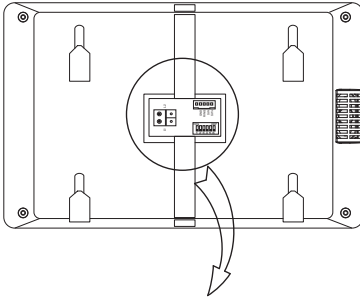

L1,L2: Bus line terminal.

SW+,SW-: Extra door bell call button connection port.

RING,GND: Extra buzzer connection port.

DIP switches: Total 6 bits can be configured.

- **Bit1~Bit5:** User Code setting.
- **Bit6:** Set to **ON** if the monitor is at the end of the line or works with DBC4A1. Otherwise, set to **OFF**.

Front panel for outdoor station

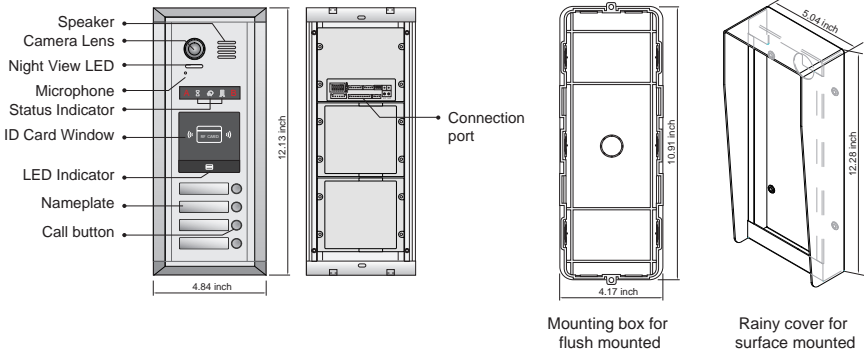

Note:Key A and key B will not be seen on the panel,they are cryptic.About activating key A and key B, please refer to Part 5.

4. Terminal Description For Outdoor Station

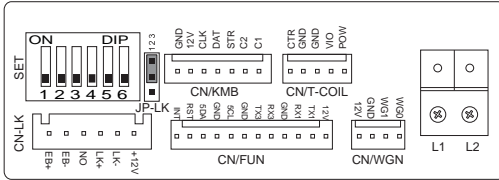

- **+12V:** 12VDC power output.
- **LK-:** Power ground. See page 14 for hook-up with DS-ERL included in kit.
- **LK+:** Common contact of the relay.
- **NO.:** Normally open contact of the relay
- **EB+:** Exit button positive connection port.
- **EB-:** Exit button negative connection port.
- **JP-LK:** For electronic lock safety type setting(refer to door lock connections).
- **SET :** DIP switches for system configurations. By default, DIP5 is on, that means the unlocking time is 5 seconds.
- **CN/KMB:** Call button module connection port.
- **CN/T-COIL:** Reserved.
- **CN/FUN:** Touch sensor keypad module or TFT display module connection port.
- **CN/WGN:** Card reader module connection port.
- **Bus(L1,L2):** Non-polarity bus line,connect to power supply.

5. Call codes

The door station automatically assigns the call codes to the connected module's buttons. Regardless of the structure of the call button module, the button numbers are listed from the top to bottom and from left to right (in the case of double row buttons):

In the case of double row buttons:

- DIP3 switch set to off

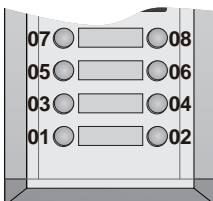

In the case of single row buttons:

- DIP3 switch set to off

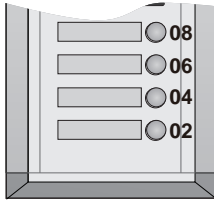

- DIP3 switch set to on

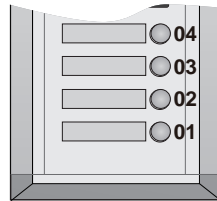

6. DIP Switches Settings Of Outdoor Station

Totally 6 bits can be configured by dip-switch. All switches can be modified either before or after installation, please restarting the power whenever the switches have been modified.

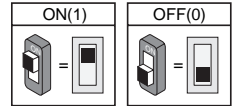

Bit definition	Bit state	Function Descriptions
Bit-1 and Bit-2 (door station ID setting)		Default setting, ID = 0, setting for the first door station
		ID = 1, setting for the second door station
		ID = 2, setting for the third door station
		ID = 3, setting for the fourth door station
Bit-3 (single or double row button setting)		Default setting ,set "OFF " when using a double row button door station
		Set "ON" when using a single row button door station
Bit-4 (button code select)		Default setting, set "OFF " when using the default codes of the button
		Set " ON " when using the programmed codes of the button.
Bit-5 (unlock time quick setting)*		Unlocking time = 1second. (can be changed by door station or software)*
		Default setting, unlocking time = 5 seconds.
Bit-6 (cryptic key setting)		Default setting, normally key A and key B is not useful.
		Activating the key A and key B is allowed.

***Check the Monitor Manual or Quick Guide for more information regarding Unlock Time Settings.**

7. Indoor Unit Parameter Setting

How to enter the installation setting page



1. Press **Setting** button in standby mode.

2. Press **Setting** button six times.

3. Press and hold **Unlock** button for 3s.

4. Use button to increase / decrease the value; use button to select next digital.

How to know the machine code

When you want to set the monitor parameter, you must to know the setting code.

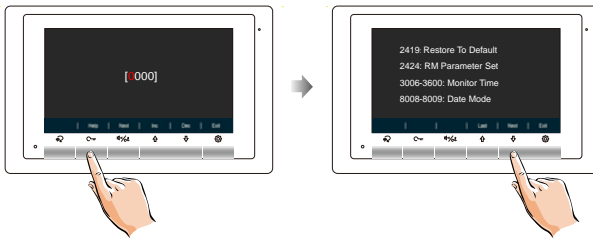

1. Press **Unlock(Help)** button in installation setting page.

4. Use button to search the code you want.



DIP Switches Settings Of Indoor Unit





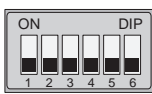



























The DIP switches are used to set the user code for each monitor. Total 6 bits can be configured.

- Bit-1 to Bit-5 are used for user code setting. The value range is from 1 to 32, which have 32 different codes for 32 apartments.
- When multi monitors need to be installed in one apartment, these monitors should use the same user code, and the master/slave mode should be set on the monitor.
- Bit-6 is bus line terminal switch, which should be set to “ON” if the monitor is at the end of bus line, otherwise be set to “OFF”.

Bit-6 switch setting



Bit state	Setting	Bit state	Setting
	When monitor is not at the end of bus line.		When monitor is at the end of bus line.

Bit state	User Code	Bit state	User Code	Bit state	User Code
	Code=1		Code=12		Code=23
	Code=2		Code=13		Code=24
	Code=3		Code=14		Code=25
	Code=4		Code=15		Code=26
	Code=5		Code=16		Code=27
	Code=6		Code=17		Code=28
	Code=7		Code=18		Code=29
	Code=8		Code=19		Code=30
	Code=9		Code=20		Code=31
	Code=10		Code=21		Code=32
	Code=11		Code=22		

8. Answering a call

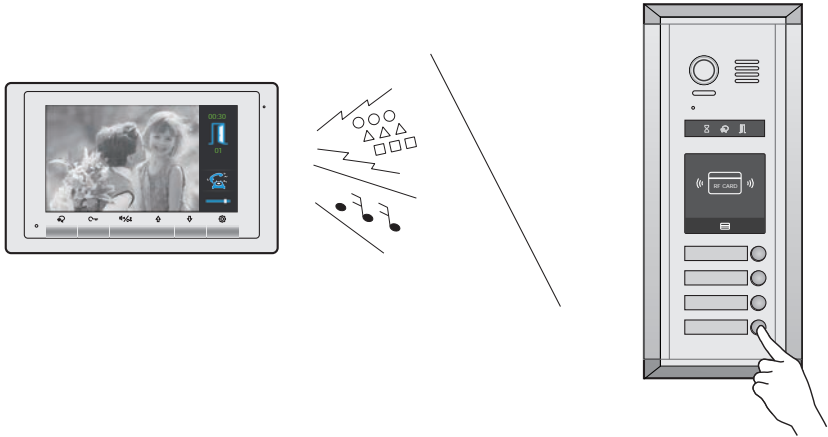

When there is a call from a video door station. The call tone sounds, an image will be displayed on the screen.

Press  **TALK/MON** button on the panel, begin communicating hands free with the visitor for 90 seconds.

While communicating with the visitor, unlock the door, adjust volume / brightness / contrast are available. More details, please refer to the user manual of indoor monitor.

Note: If nobody answers the phone, the screen will be turned off automatically after 40 seconds.

9. Electric Lock Connection(NOT RECOMMENDED). See Page 14.

Note: NOT RECOMMENDED unless the door lock is less than 250mA. Please see Page 14 for HOW TO HOOK UP A DOOR RELEASE.

1) Door Lock Controlled with Internal Power

1. The door lock is limited to 12Vdc, and holding current must be less than 250mA when using internal power supply mode.
2. The **Unlock Mode Parameter** must be set to 0 (by default).
3. Jumper set to 1-2 position for power-off-to-unlock safety type(*Normally closed mode*); set to 2-3 position for power-on-to -unlock type(*Normally open mode*).
4. If different unlocking time is needed,change the unlock time on door station,detail information refer to DT system technical guide .

Power-on-to-Unlock type:

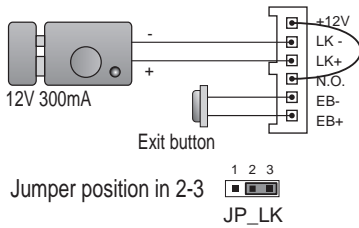

Power-off-to-Unlock type:

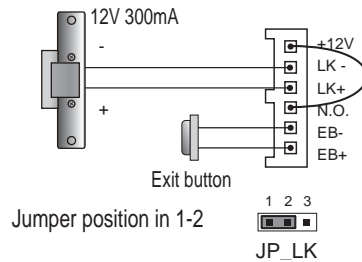

2) Door Lock Controlled with External Power

1. The external power supply must be used according to the lock.
2. The jumper must be taken off before connecting.
3. Setup the **Unlock Mode Parameter** for different lock types
 - Power-on-to-unlock type:Unlock Mode=0(by default)
 - Power-off-to-unlock type:Unlock Mode=1
4. If different unlocking time is needed, change the unlock time on door station,detail information refer to DT system technical guide .

Power-on-to-Unlock type:

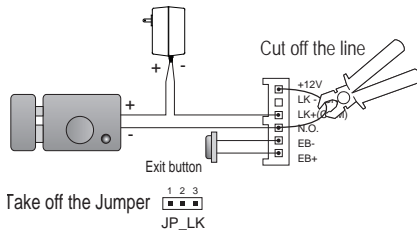

Power-off-to-Unlock type:

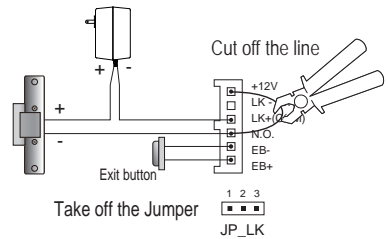

10. Specification

Power supply:	26Vdc
Power Consumption Of Outdoor Station:	1W in standby; 5W in working.
Power Consumption Of Indoor Unit:	0.17W in standby; 6.2W in working.
Unlock Power output:	12Vdc, 250mA
Unlock timing:	1~99s
Working temperature:	- 20°C ~ +55°C
Wiring:	2 wire, non-polarity
Dimension:	5.51(H)×8.66(W)×0.69(D)inch(Indoor Unit) 12.32(H)×5.04(W)×2.48(D)inch(flush) 12.32(H)×5.04(W)×2.76(D)inch(surface)

11. Hooking up a door release

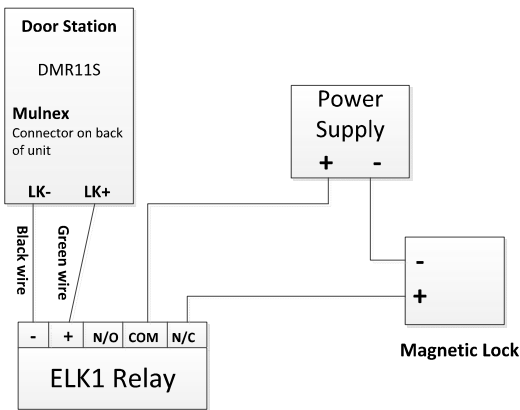
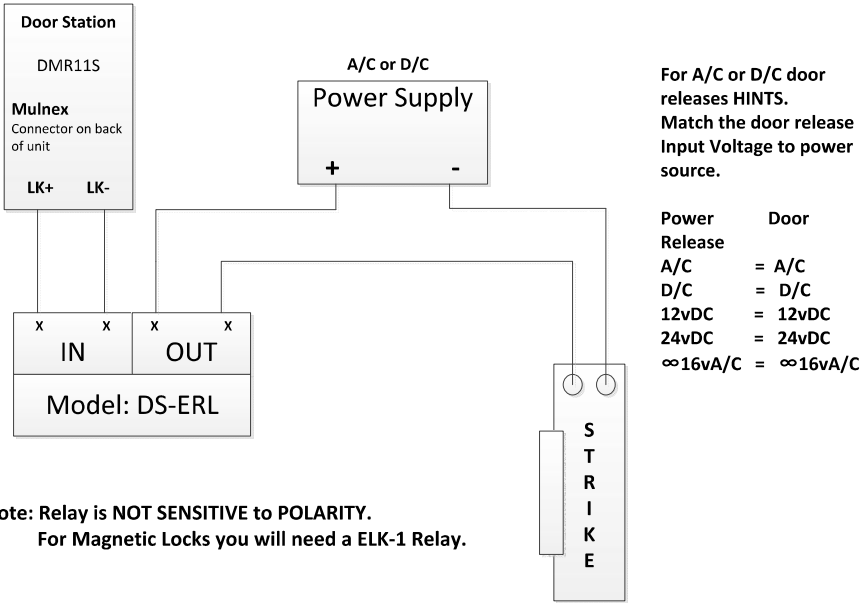

Power Supply can be A/C or D/C as long as it matches the needs of the magnetic lock.

By hooking up the ELK1 to the door release this saves the outdoor station from being damaged which is NOT covered by the warranty!

The reason for this is that all Door Stations have spikes in voltage and the panel relay Max is 200mA.

Note: The mulnex Connector is located on the back of the outdoor station, and the black wire used for the connection is the second wire from the top next to the green wire.

